

DATA SHEET

BLW86 HF/VHF power transistor

Product specification

August 1986

HF/VHF power transistor

BLW86

DESCRIPTION

N-P-N silicon planar epitaxial transistor intended for use in class-A, AB and B operated h.f. and v.h.f. transmitters with a nominal supply voltage of 28 V. The transistor is resistance stabilized and is guaranteed to withstand severe load mismatch conditions. Matched h_{FE} groups are available on request.

It has a 3/8" flange envelope with a ceramic cap. All leads are isolated from the flange.

QUICK REFERENCE DATA

R.F. performance up to $T_h = 25\text{ }^\circ\text{C}$

MODE OF OPERATION	V_{CE} V	f MHz	P_L W	G_p dB	η %	\bar{z}_i Ω	\bar{Y}_L mS	d_3 dB
c.w. (class-B)	28	175	45	> 7,5	> 70	$0,7 + j1,3$	$110 - j62$	-
s.s.b. (class-AB)	28	1,6 - 28	5-47,5 (P.E.P.)	typ. 19	typ. 45	-	-	typ. -30
s.s.b. (class-A)	26	1,6 - 28	17 (P.E.P.)	typ. 22	-	-	-	typ. -42

PIN CONFIGURATION

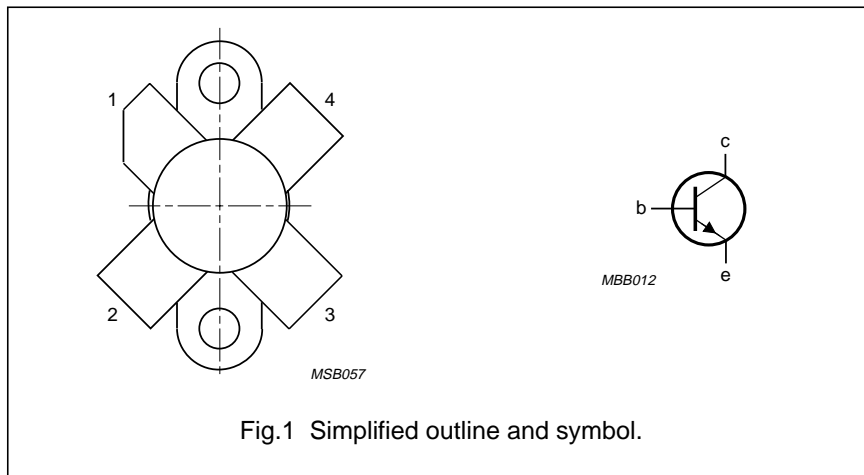

PINNING - SOT123

PIN	DESCRIPTION
1	collector
2	emitter
3	base
4	emitter

PRODUCT SAFETY This device incorporates beryllium oxide, the dust of which is toxic. The device is entirely safe provided that the BeO disc is not damaged.

HF/VHF power transistor

BLW86

RATINGS

Limiting values in accordance with the Absolute Maximum System (IEC 134)

Collector-emitter voltage ($V_{BE} = 0$)

peak value

V_{CESM} max. 65 V

Collector-emitter voltage (open base)

V_{CEO} max. 36 V

Emitter-base voltage (open-collector)

V_{EBO} max. 4 V

Collector current (average)

$I_{C(AV)}$ max. 4 A

Collector current (peak value); $f > 1$ MHz

I_{CM} max. 12 A

R.F. power dissipation ($f > 1$ MHz); $T_{mb} = 25$ °C

P_{rf} max. 105 W

Storage temperature

T_{stg} -65 to + 150 °C

Operating junction temperature

T_j max. 200 °C

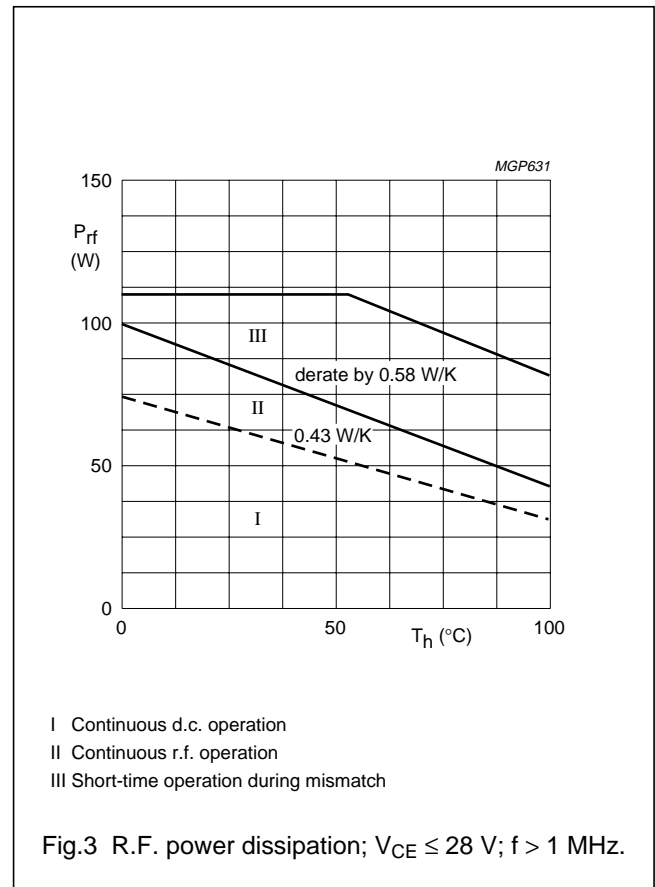
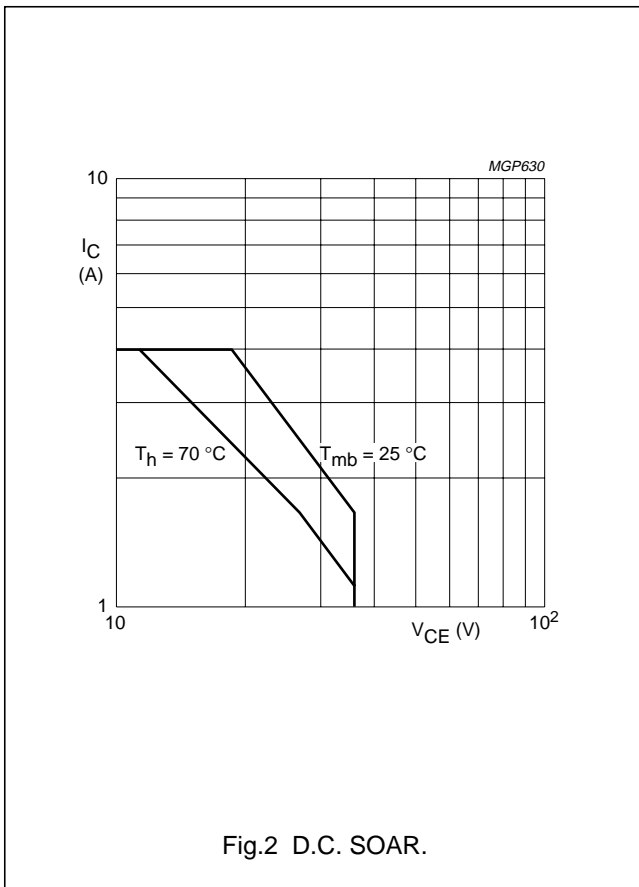

THERMAL RESISTANCE

(dissipation = 45 W; $T_{mb} = 83,5$ °C, i.e. $T_h = 70$ °C)

From junction to mounting base (d.c. dissipation)

$R_{th\ j-mb(dc)}$ = 2,65 K/W

From junction to mounting base (r.f. dissipation)

$R_{th\ j-mb(rf)}$ = 1,95 K/W

From mounting base to heatsink

$R_{th\ mb-h}$ = 0,3 K/W

HF/VHF power transistor

BLW86

CHARACTERISTICS

$T_j = 25\text{ }^\circ\text{C}$ unless otherwise specified

Collector-emitter breakdown voltage $V_{BE} = 0; I_C = 25\text{ mA}$	$V_{(BR)CES}$	>	65 V
Collector-emitter breakdown voltage open base; $I_C = 100\text{ mA}$	$V_{(BR)CEO}$	>	36 V
Emitter-base breakdown voltage open collector; $I_E = 10\text{ mA}$	$V_{(BR)EBO}$	>	4 V
Collector cut-off current $V_{BE} = 0; V_{CE} = 36\text{ V}$	I_{CES}	<	10 mA
Second breakdown energy; $L = 25\text{ mH}; f = 50\text{ Hz}$ open base	E_{SBO}	>	8 mJ
$R_{BE} = 10\text{ }\Omega$	E_{SBR}	>	8 mJ
D.C. current gain ⁽¹⁾ $I_C = 2,5\text{ A}; V_{CE} = 5\text{ V}$	h_{FE}	typ.	45 10 to 80
D.C. current gain ratio of matched devices ⁽¹⁾ $I_C = 2,5\text{ A}; V_{CE} = 5\text{ V}$	h_{FE1}/h_{FE2}	<	1,2
Collector-emitter saturation voltage ⁽¹⁾ $I_C = 7,5\text{ A}; I_B = 1,5\text{ A}$	V_{CEsat}	typ.	1,5 V
Transition frequency at $f = 100\text{ MHz}$ ⁽¹⁾ $-I_E = 2,5\text{ A}; V_{CB} = 28\text{ V}$	f_T	typ.	570 MHz
$-I_E = 7,5\text{ A}; V_{CB} = 28\text{ V}$	f_T	typ.	570 MHz
Collector capacitance at $f = 1\text{ MHz}$ $I_E = I_e = 0; V_{CB} = 28\text{ V}$	C_c	typ.	82 pF
Feedback capacitance at $f = 1\text{ MHz}$ $I_C = 100\text{ mA}; V_{CE} = 28\text{ V}$	C_{re}	typ.	54 pF
Collector-flange capacitance	C_{cf}	typ.	2 pF

Note

1. Measured under pulse conditions: $t_p \leq 200\text{ }\mu\text{s}; \delta \leq 0,02$.

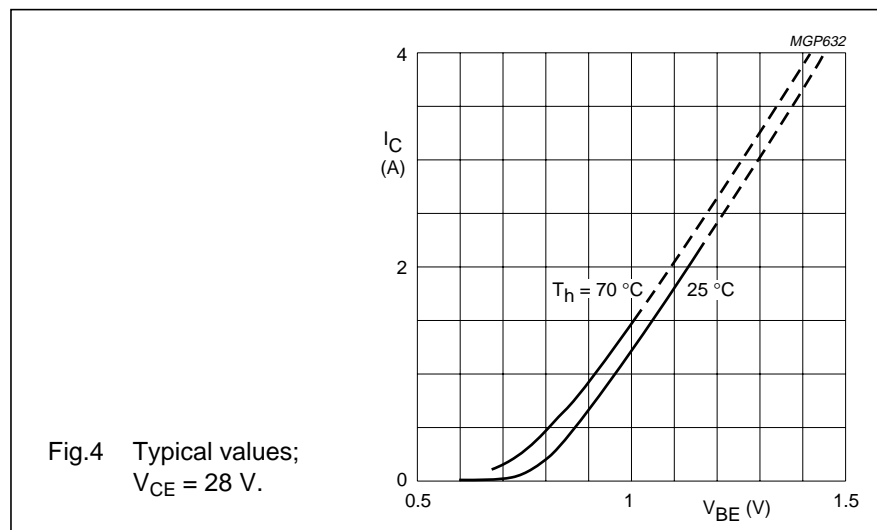

HF/VHF power transistor

BLW86

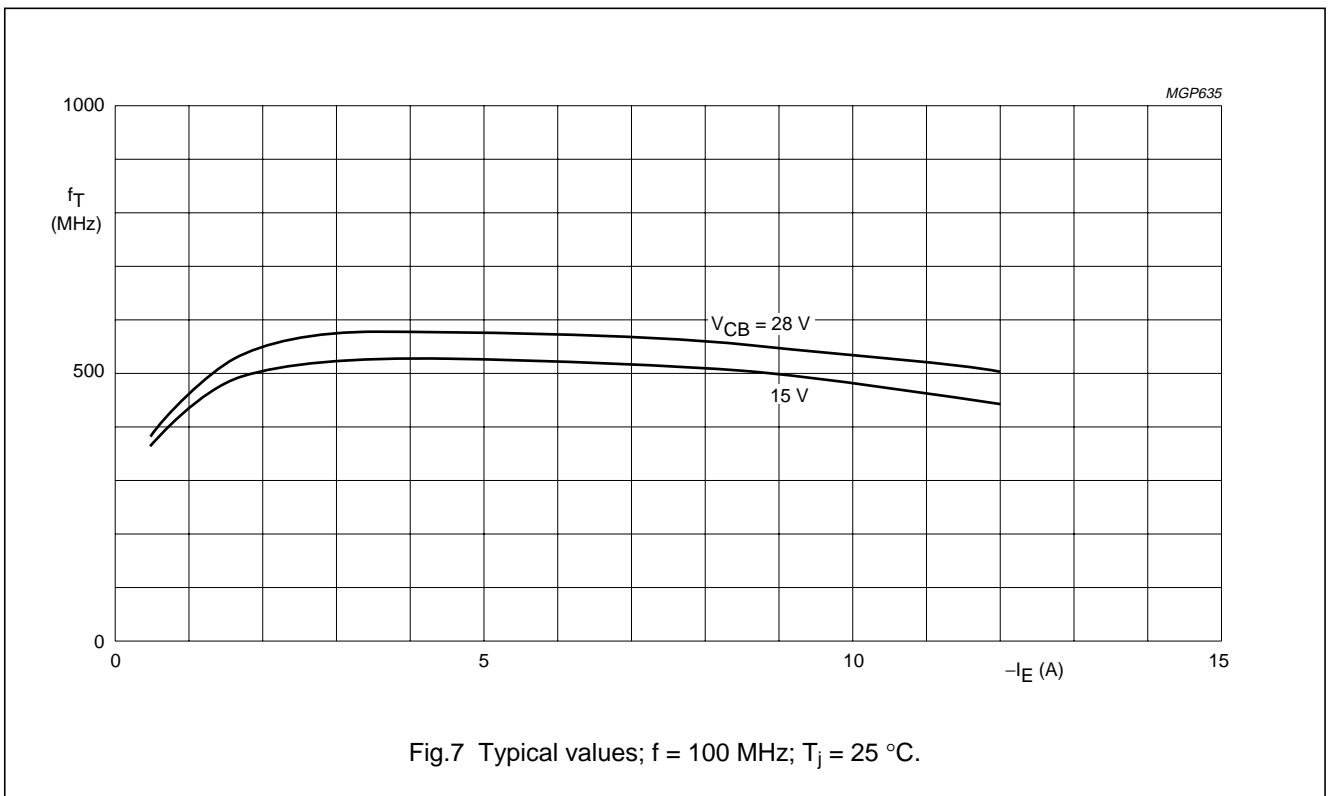
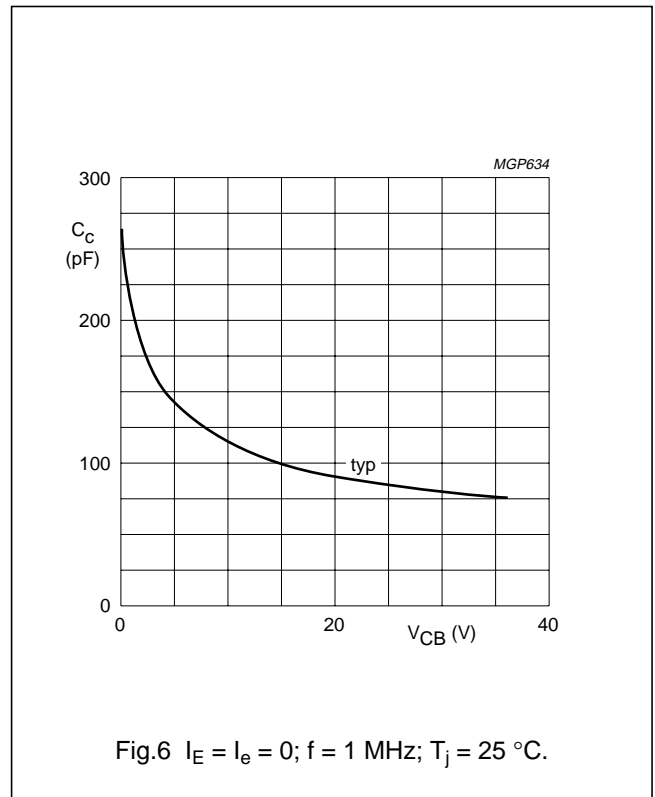
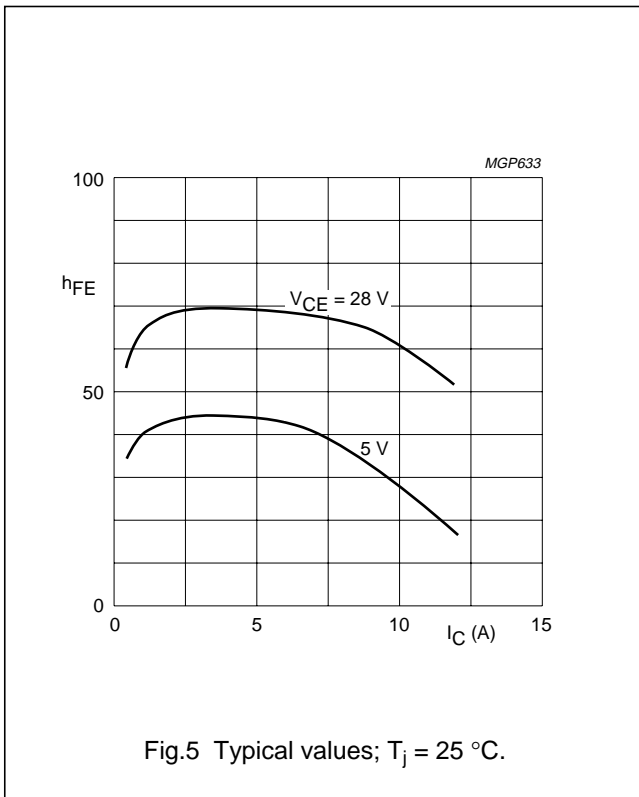

HF/VHF power transistor

BLW86

APPLICATION INFORMATION

R.F. performance in c.w. operation (unneutralized common-emitter class-B circuit); $T_h = 25\text{ }^\circ\text{C}$

f (MHz)	V_{CE} (V)	P_L (W)	P_S (W)	G_P (dB)	I_C (A)	η (%)	\bar{z}_i (Ω)	\bar{Y}_L (mS)
175	28	45	< 8	> 7,5	< 2,47	> 70	$0,7 + j1,3$	$110 - j62$

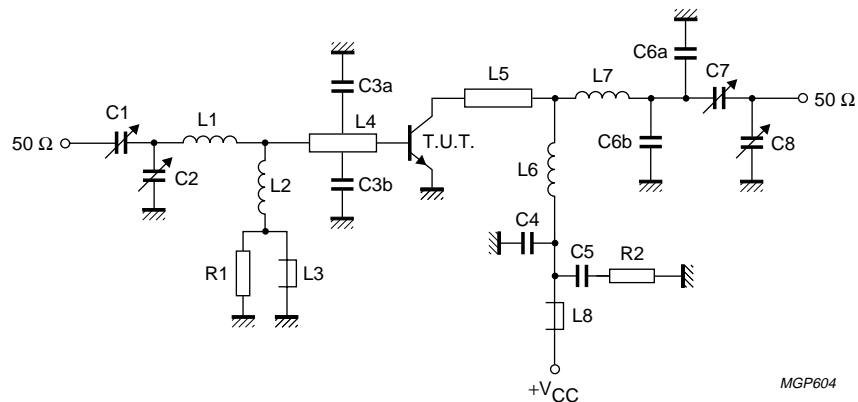

Fig.8 Test circuit; c.w. class-B.

List of components:

- C1 = C7 = 2,5 to 20 pF film dielectric trimmer (cat. no. 2222 809 07004)
- C2 = 5 to 60 pF film dielectric trimmer (cat. no. 2222 809 07011)
- C3a = C3b = 47 pF ceramic capacitor (500 V)
- C4 = 120 pF ceramic capacitor
- C5 = 100 nF polyester capacitor
- C6a = 2,2 pF ceramic capacitor (500 V)
- C6b = 1,8 pF ceramic capacitor (500 V)
- C8 = 4 to 40 pF film dielectric trimmer (cat. no. 2222 809 07008)
- L1 = 14 nH; 1 turn Cu wire (1,6 mm); int. dia. 7,7 mm; leads 2×5 mm
- L2 = 100 nH; 7 turns closely wound enamelled Cu wire (0,5 mm); int. dia. 3 mm; leads 2×5 mm
- L3 = L8 = Ferroxcube wide-band h.f. choke, grade 3B (cat. no. 4312 020 36640)
- L4 = L5 = strip (12 mm \times 6 mm); taps for C3a and C3b at 5 mm from transistor
- L6 = 80 nH; 3 turns Cu wire (1,6 mm); int. dia. 9,0 mm; length 8,0 mm; leads 2×5 mm
- L7 = 62 nH; 3 turns Cu wire (1,6 mm); int. dia. 7,5 mm; length 8,1 mm; leads 2×5 mm

L4 and L5 are strips on a double Cu-clad printed-circuit board with epoxy fibre-glass dielectric, thickness 1/6".

R1 = R2 = 10 Ω carbon resistor

Component layout and printed-circuit board for 175 MHz test circuit see Fig.9.

HF/VHF power transistor

BLW86

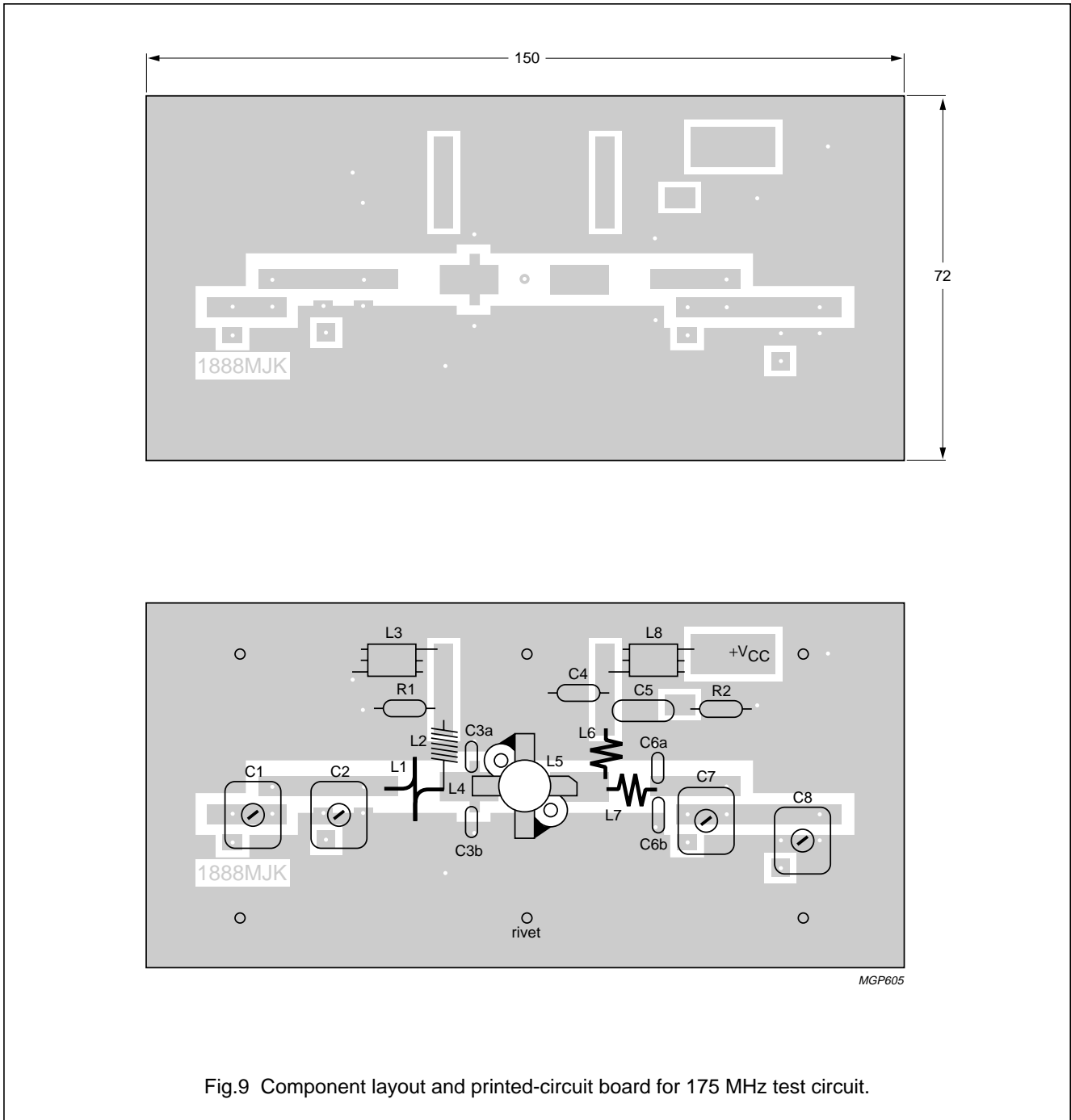

Fig.9 Component layout and printed-circuit board for 175 MHz test circuit.

The circuit and the components are situated on one side of the epoxy fibre-glass board, the other side being fully metallized to serve as earth. Earth connections are made by means of hollow rivets, whilst under the emitter leads Cu straps are used for a direct contact between upper and lower sheets.

To minimize the dielectric losses, the ground plane under the interconnection of L7 and C7 has been removed.

HF/VHF power transistor

BLW86

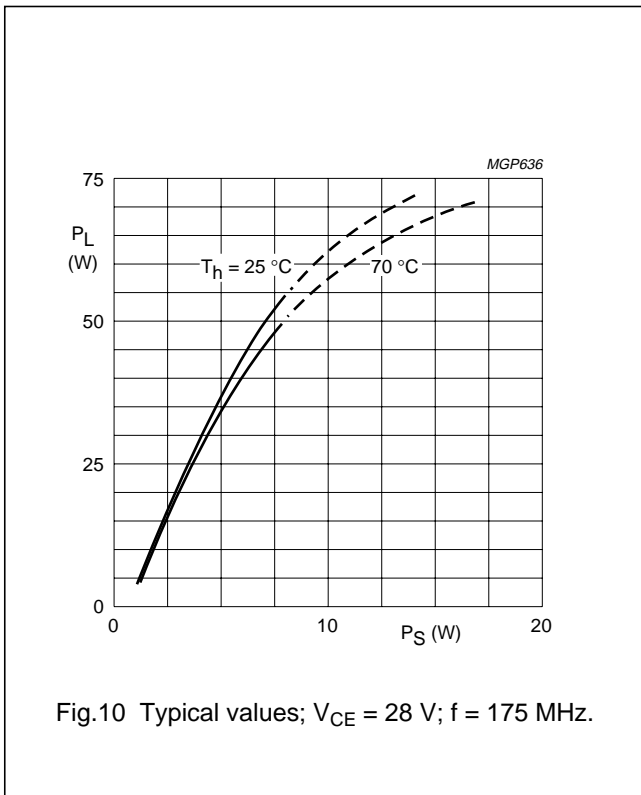

Fig.10 Typical values; $V_{CE} = 28 \text{ V}$; $f = 175 \text{ MHz}$.

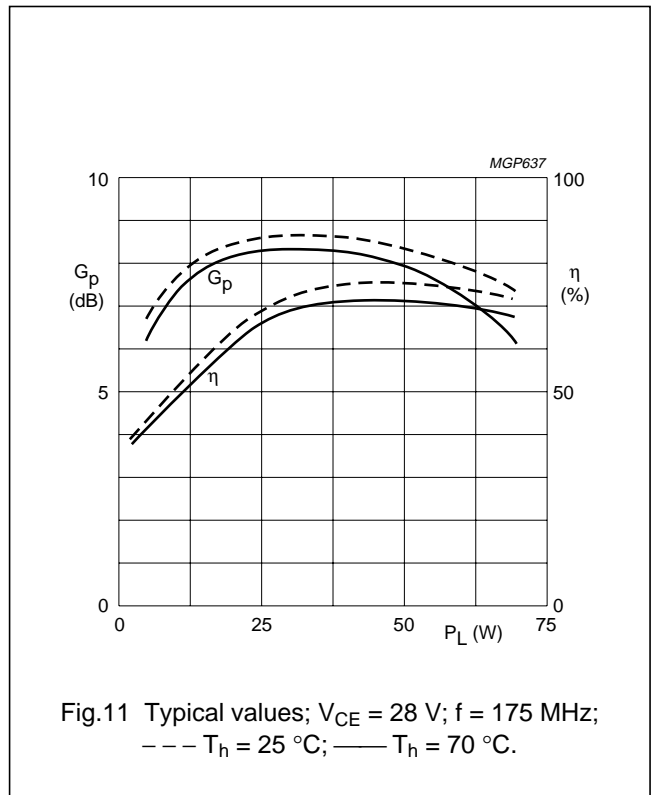
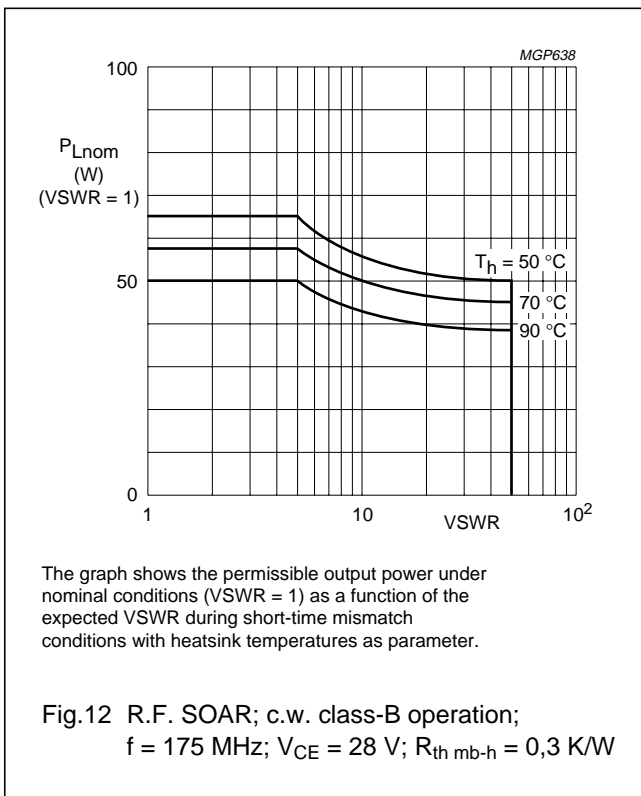

Fig.11 Typical values; $V_{CE} = 28 \text{ V}$; $f = 175 \text{ MHz}$;
 --- $T_h = 25 \text{ °C}$; — $T_h = 70 \text{ °C}$.



The graph shows the permissible output power under nominal conditions ($VSWR = 1$) as a function of the expected VSWR during short-time mismatch conditions with heatsink temperatures as parameter.

Fig.12 R.F. SOAR; c.w. class-B operation;
 $f = 175 \text{ MHz}$; $V_{CE} = 28 \text{ V}$; $R_{th\ mb-h} = 0,3 \text{ K/W}$

HF/VHF power transistor

BLW86

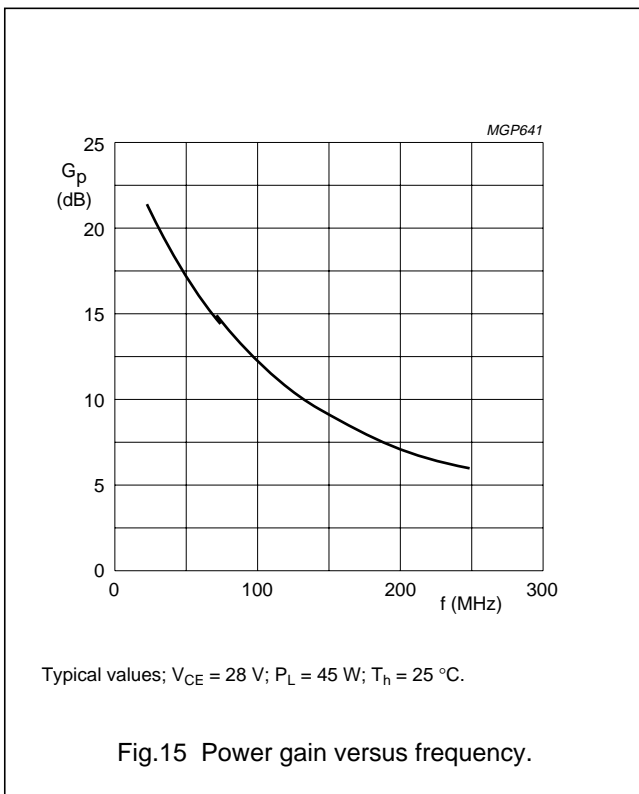
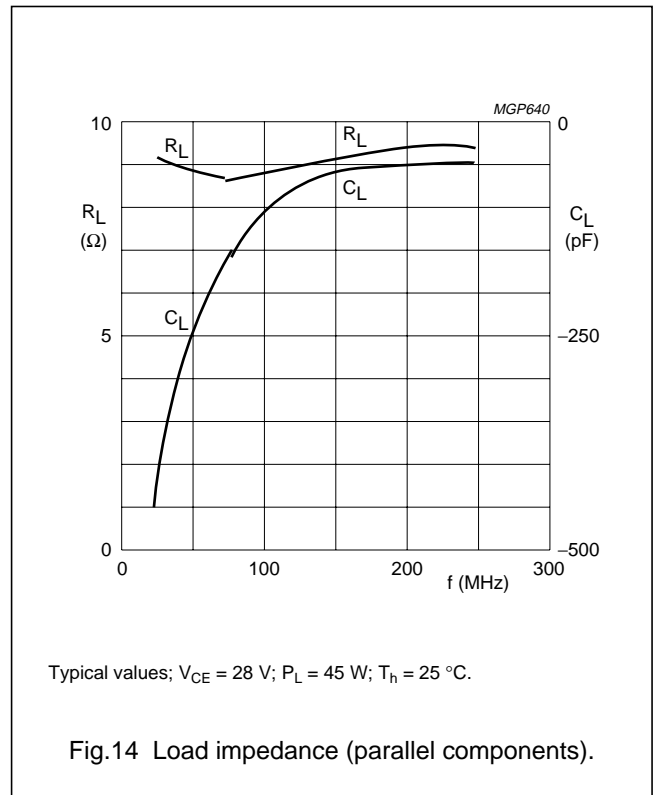
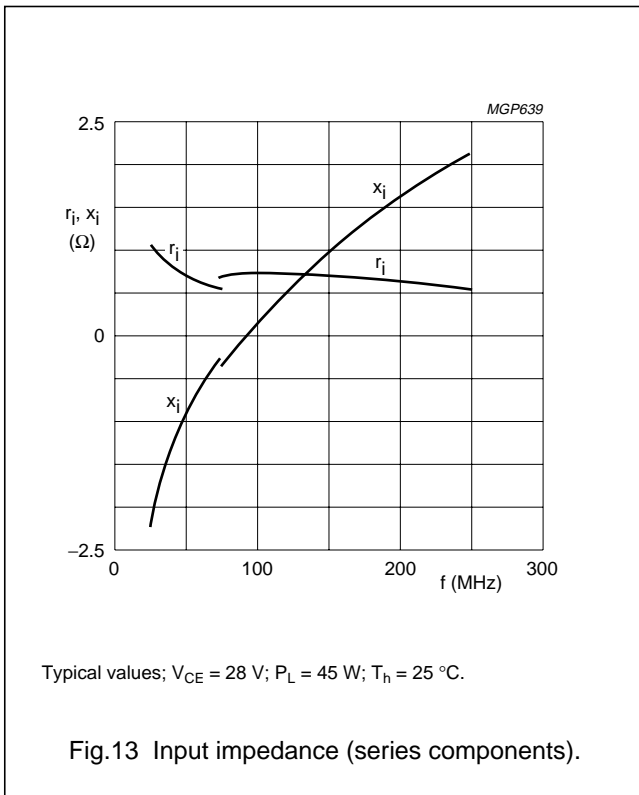

OPERATING NOTE

Below 75 MHz a base-emitter resistor of 10 Ω is recommended to avoid oscillation. This resistor must be effective for r.f. only.

HF/VHF power transistor

BLW86

R.F. performance in s.s.b. class-AB operation (linear power amplifier)

 $V_{CE} = 28 \text{ V}$; $f_1 = 28,000$; $f_2 = 28,001 \text{ MHz}$.

OUTPUT POWER W	G_P dB	η_{dt} (%) at 47,5 W	I_C (A) (P.E.P.)	d_3 dB ⁽¹⁾	d_5 dB ⁽¹⁾	$I_{C(zs)}$ mA	T_h °C
5 to 47,5 (P.E.P.)	typ. 19	typ. 45	typ. 1,9	typ. -30	< -30	50	25
5 to 42,5 (P.E.P.)	typ. 19	-	-	typ. -30	< -30	50	70

Note

1. Stated intermodulation distortion figures are referred to the according level of either of the equal amplified tones. Relative to the according peak envelope powers these figures should be increased by 6 dB.

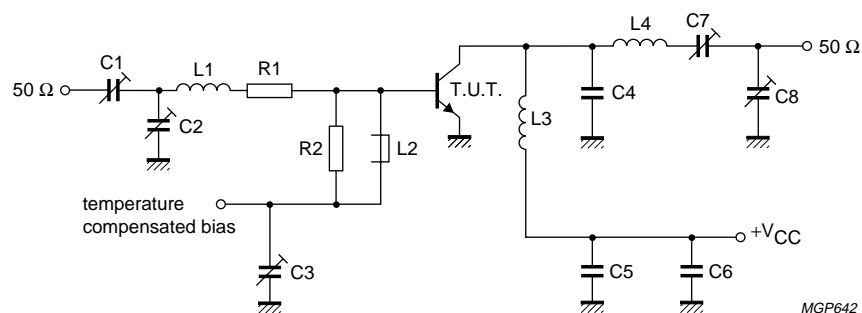

Fig.16 Test circuit; s.s.b. class-AB.

List of components:

C1 = C2 = 10 to 780 pF film dielectric trimmer

C3 = C5 = C6 = 220 nF polyester capacitor

C4 = 56 pF ceramic capacitor (500 V)

C7 = C8 = 15 to 575 pF film dielectric trimmer

L1 = 4 turns closely wound enamelled Cu wire (1,6 mm); int. dia. 7,0 mm; leads 2 × 5 mm

L2 = Ferroxcube wide-band h.f. choke, grade 3B (cat. no. 4312 020 36640)

L3 = 4 turns enamelled Cu wire (1,6 mm); int. dia. 10 mm; length 9,4 mm; leads 2 × 5 mm

L4 = 7 turns enamelled Cu wire (1,6 mm); int. dia. 12 mm; length 17,2 mm; leads 2 × 5 mm

R1 = 1,2 Ω; parallel connection of 4 × 4,7 Ω carbon resistors

R2 = 39 Ω carbon resistor

HF/VHF power transistor

BLW86

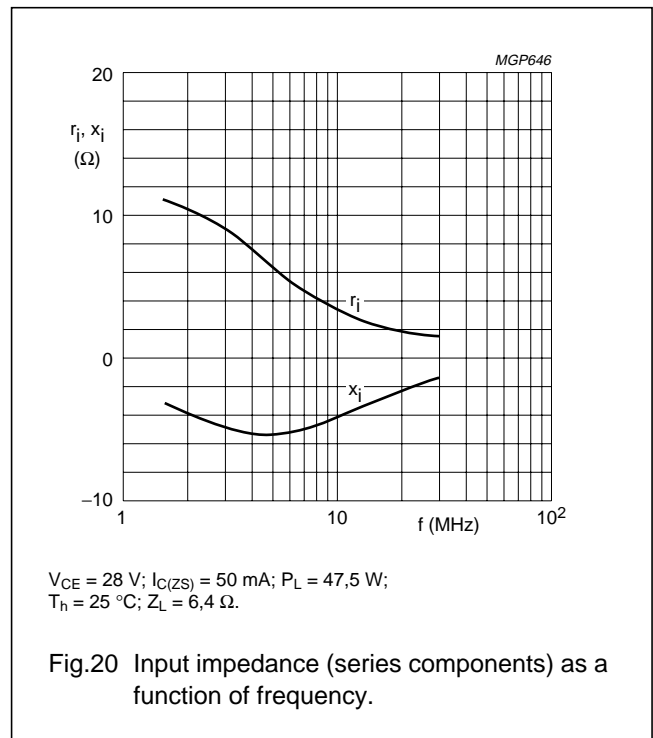
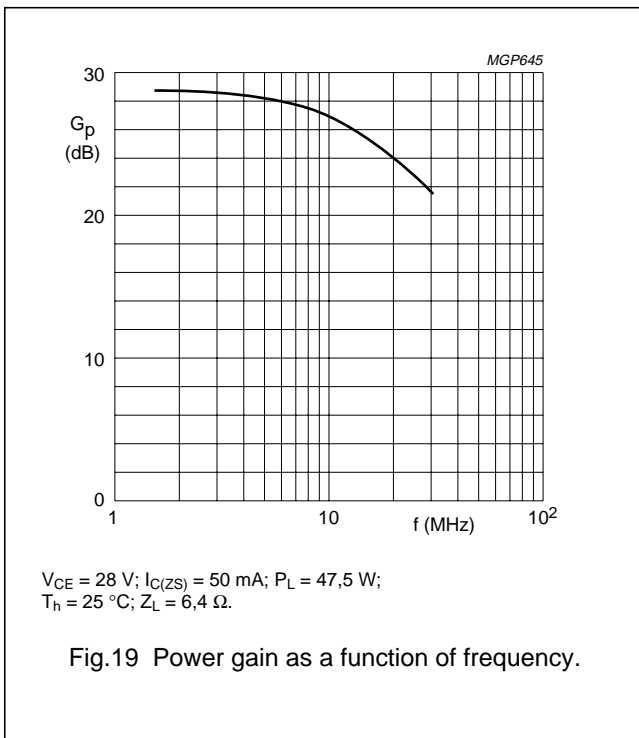
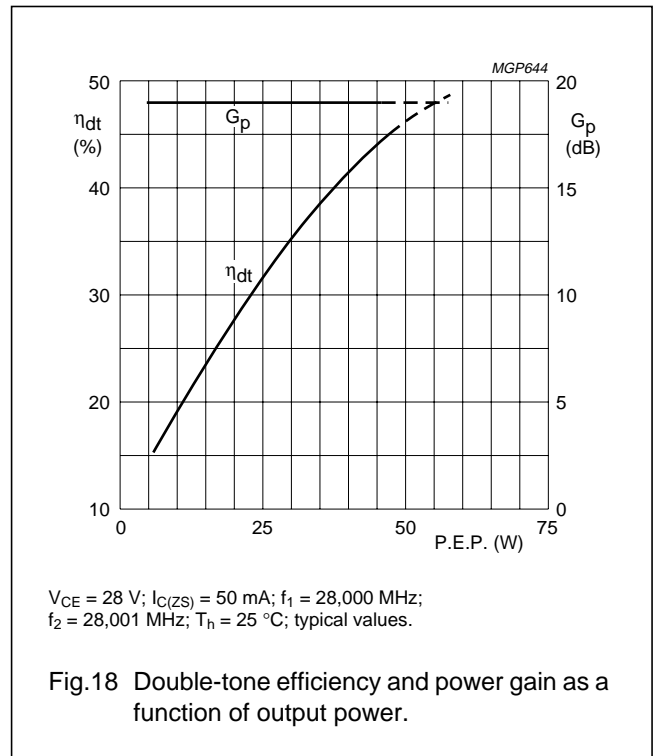
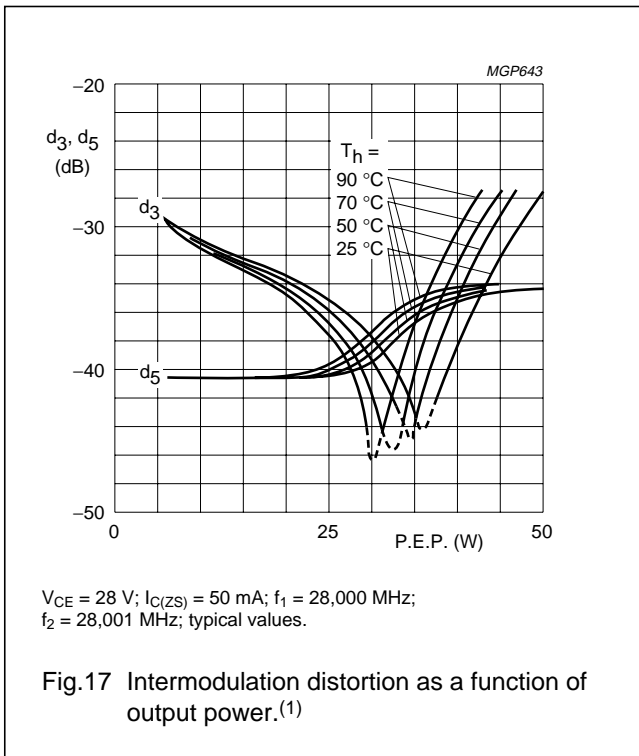

Figs 19 and 20 are typical curves and hold for an unneutralized amplifier in s.s.b. class-AB operation.

HF/VHF power transistor

BLW86

Ruggedness in s.s.b. operation

The BLW86 is capable of withstanding a load mismatch (VSWR = 50) under the following conditions: class-AB operation; $f_1 = 28,000$ MHz; $f_2 = 28,001$ MHz; $V_{CE} = 28$ V; $T_h = 70$ °C and $P_{Lnom} = 50$ W P.E.P.

R.F. performance in s.s.b. class-A operation (linear power amplifier)

$V_{CE} = 26$ V; $f_1 = 28,000$ MHz; $f_2 = 28,001$ MHz

OUTPUT POWER W	G _p dB	I _c A	d ₃ dB ⁽¹⁾	d ₅ dB ⁽¹⁾	T _h °C
17 (P.E.P.)	typ. 22	1,7	typ. -40	< -40	70
17 (P.E.P.)	typ. 22	1,7	typ. -42	< -40	25

Note

1. Stated intermodulation distortion figures are referred to the according level of either of the equal amplified tones. Relative to the according peak envelope powers these figures should be increased by 6 dB.

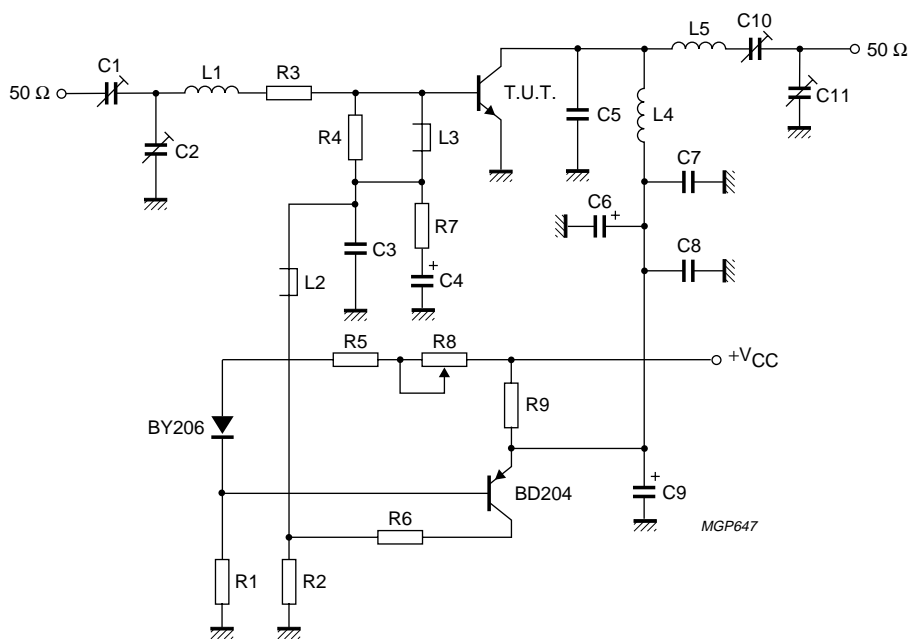

Fig.21 Test circuit; s.s.b. class-A.

HF/VHF power transistor

BLW86

List of components in Fig.21:

C1 = C2 = 10 to 780 pF film dielectric trimmer

C3 = 22 nF ceramic capacitor (63 V)

C4 = 47 μ F/10 V electrolytic capacitor

C5 = 56 pF ceramic capacitor (500 V)

C6 = 47 μ F/35 V electrolytic capacitor

C7 = C8 = 220 nF polyester capacitor

C9 = 10 μ F/35 V electrolytic capacitor

C10 = 10 to 210 pF film dielectric trimmer

C11 = 15 to 575 pF film dielectric trimmer

L1 = 3 turns closely wound enamelled Cu wire (1,6 mm); int. dia. 9,0 mm; leads 2×5 mm

L2 = L3 = Ferroxcube wide-band h.f. choke, grade 3B (cat. no. 4312 020 36640)

L4 = 11 turns closely wound enamelled Cu wire (1,6 mm); int. dia. 11,0 mm

L5 = 14 turns closely wound enamelled Cu wire (1,6 mm); int. dia. 11,0 mm

R1 = 600 Ω ; parallel connection of $2 \times 1,2$ k Ω carbon resistors ($\pm 5\%$; 0,5 W each)

R2 = 15 Ω carbon resistor ($\pm 5\%$; 0,25 W)

R3 = 1,2 Ω ; parallel connection of $4 \times 4,7$ Ω carbon resistors ($\pm 5\%$; 0,125 W each)

R4 = 33 Ω carbon resistor ($\pm 5\%$; 0,25 W)

R5 = 18 Ω carbon resistor ($\pm 5\%$; 0,25 W)

R6 = 120 Ω wirewound resistor ($\pm 5\%$; 5,5 W)

R7 = 1 Ω carbon resistor ($\pm 5\%$; 0,125 W)

R8 = 47 Ω wirewound potentiometer (3 W)

R9 = 1,57 Ω ; parallel connection of $3 \times 4,7$ Ω wirewound resistors ($\pm 5\%$; 5,5 W each)

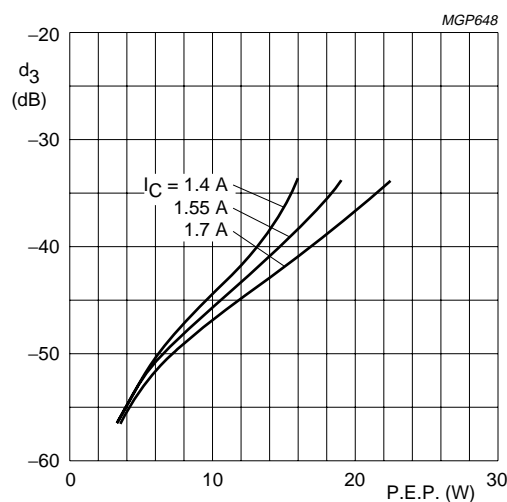

Fig.22 Intermodulation distortion as a function of output power. Typical values; $V_{CE} = 26$ V; $T_h = 70$ °C;
 $f_1 = 28,000$ MHz; $f_2 = 28,001$ MHz.

HF/VHF power transistor

BLW86

PACKAGE OUTLINE

Flanged ceramic package; 2 mounting holes; 4 leads

SOT123A

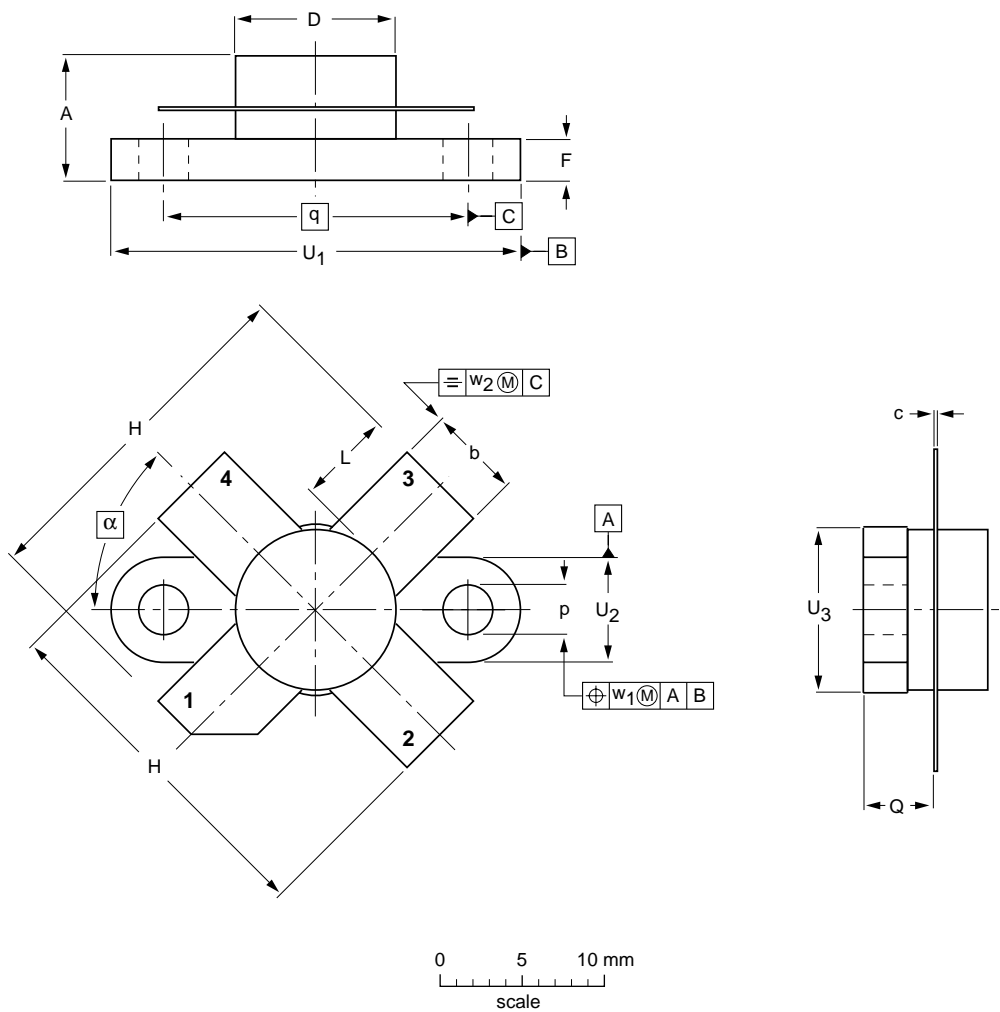

DIMENSIONS (millimetre dimensions are derived from the original inch dimensions)

UNIT	A	b	c	D	D ₁	F	H	L	p	Q	q	U ₁	U ₂	U ₃	w ₁	w ₂	α
mm	7.47 6.37	5.82 5.56	0.18 0.10	9.73 9.47	9.63 9.42	2.72 2.31	20.71 19.93	5.61 5.16	3.33 3.04	4.63 4.11	18.42	25.15 24.38	6.61 6.09	9.78 9.39	0.51	1.02	45°
inches	0.294 0.251	0.229 0.219	0.007 0.004	0.383 0.373	0.397 0.371	0.107 0.091	0.815 0.785	0.221 0.203	0.131 0.120	0.182 0.162	0.725	0.99 0.96	0.26 0.24	0.385 0.370	0.02	0.04	

OUTLINE VERSION	REFERENCES				EUROPEAN PROJECTION	ISSUE DATE
	IEC	JEDEC	EIAJ			
SOT123A						97-06-28

HF/VHF power transistor

BLW86

DEFINITIONS

Data Sheet Status	
Objective specification	This data sheet contains target or goal specifications for product development.
Preliminary specification	This data sheet contains preliminary data; supplementary data may be published later.
Product specification	This data sheet contains final product specifications.
Limiting values	
Limiting values given are in accordance with the Absolute Maximum Rating System (IEC 134). Stress above one or more of the limiting values may cause permanent damage to the device. These are stress ratings only and operation of the device at these or at any other conditions above those given in the Characteristics sections of the specification is not implied. Exposure to limiting values for extended periods may affect device reliability.	
Application information	
Where application information is given, it is advisory and does not form part of the specification.	

LIFE SUPPORT APPLICATIONS

These products are not designed for use in life support appliances, devices, or systems where malfunction of these products can reasonably be expected to result in personal injury. Philips customers using or selling these products for use in such applications do so at their own risk and agree to fully indemnify Philips for any damages resulting from such improper use or sale.